

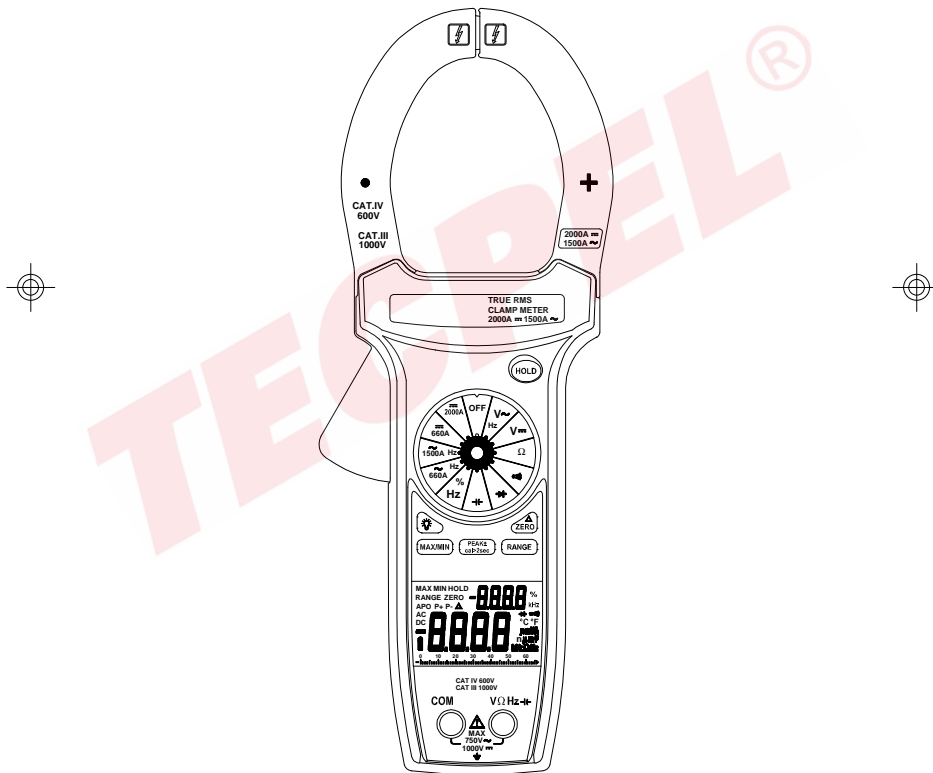

# OPERATING INSTRUCTIONS

## DIGITAL CLAMP METER





## CONTENTS

INTRODUCTION .....	1
UNPACKING AND INSPECTION .....	1
SAFETY PRECAUTIONS .....	1
SAFETY INFORMATION .....	3
INSTRUMENT LAYOUT .....	4
HOW TO MAKE MEASUREMENTS .....	7
Voltage Measurements .....	7
Current Measurements .....	8
Resistance Measurements .....	9
Continuity Measurements .....	9
Diode Tests .....	9
Capacitance Measurement .....	10
Frequency Measurements .....	10
%Duty Cycle Measurements .....	10
SPECIFICATIONS .....	11
MAINTENANCE .....	16
Replacing the Battery .....	16





## INTRODUCTION

This manual contains information and warnings which must be followed to ensure safe operation and retain the meter in safe condition.

### WARNING

READ "SAFETY INFORMATION" BEFORE USING THE METER.

This clamp meter is a handheld 6600-count instrument that is designed for use in the laboratory, field servicing, at home, and any circumstance where high current measurement is required. The clamp meter is built with a design of finger guard which ensures users operating the instrument under a safety situation; a rugged case that is shock resistant and fire-retardant; and electronic overload protection for all functions and ranges. In addition, a carrying case (optional accessory) is available for easy portability of the meter and avoiding damage.



## UNPACKING AND INSPECTION

Upon removing your new Digital Clamp Meter (DCM) from its packing, you should have the following items:

1. Digital Clamp Meter
2. Test Lead Set (one black, one red)
3. 9-Volt Battery (installed in meter)
4. Instruction Manual

If any of the above items are missing or are received in a damaged condition, please contact the distributor from whom you purchased the unit.

## SAFETY PRECAUTIONS:

The following safety precautions must be observed to ensure maximum personal safety during the operation, service and repair of this meter:

1





1. Read these operating instructions thoroughly and completely before operating your meter. Pay particular attention to WARNINGS which will inform you of potentially dangerous procedures. The instructions in these warnings must be followed.
2. Always inspect your meter, test leads and accessories for any sign of damage or abnormality before every use. If any abnormal conditions exist (eg-broken test leads, cracked cases, display not reading, etc.), do not attempt to take any measurements.
3. Do not expose the instrument to direct sun light, extreme temperature or moisture.
4. Never ground yourself when taking electrical measurements. Do not touch exposed metal pipes, outlets, fixtures, etc., which might be at ground potential. Keep your body isolated from ground by using dry clothing, rubber shoes, rubber mats, or any approved insulating material.
5. To avoid electric shock use CAUTION when working with voltages above 40 Vdc or 20 Vac. Such voltages pose a shock hazard.
6. Never exceed the maximum allowable input value of any function when taking a measurement. Refer to the specifications for maximum inputs.
7. Never touch exposed wiring, connections or any live circuit when attempting to take measurements.
8. Do not attempt to operate this instrument in an explosive atmosphere (i.e. in the presence of flammable gases or fumes, vapor or dust).
9. When testing for the presence of voltage, make sure the voltage function is operating properly by reading a known voltage in that function before assuming that a zero reading indicates a no-voltage condition. Always test your meter before and after taking measurements on a known live circuit.
10. Calibration and repair of any instrument should only be performed by qualified and trained service technicians.
11. Do not attempt calibration or service unless trained and another person capable of rendering first aid and resuscitation is present.
12. Remember: Think Safety, Act Safely.





## SAFETY INFORMATION

### Cleaning

Wipe the case with a damp cloth and mild detergent. Do not use abrasives or solvents. Dirt or moisture in the terminals can affect readings.



**Safety:** Conforms to IEC 61010-1 (EN 61010-1), IEC 61010-2-032 (EN 61010-2-032), CAT III 1000V, CAT IV 600V, Class II, Pollution degree 2 Indoor use.

CAT III: Is for measurements performed in the building installation.

CAT IV: Is for measurements performed at the source of the low-voltage installation.

EMC: Conforms to EN 61326-1: 2006



### The symbols used on this instrument are:

 Dangerous voltage.

 Caution, refer to accompanying documents

 Equipment protected throughout by Double insulation (Class II)

 Alternating current

 Direct current

 Ground





## INSTRUMENT LAYOUT

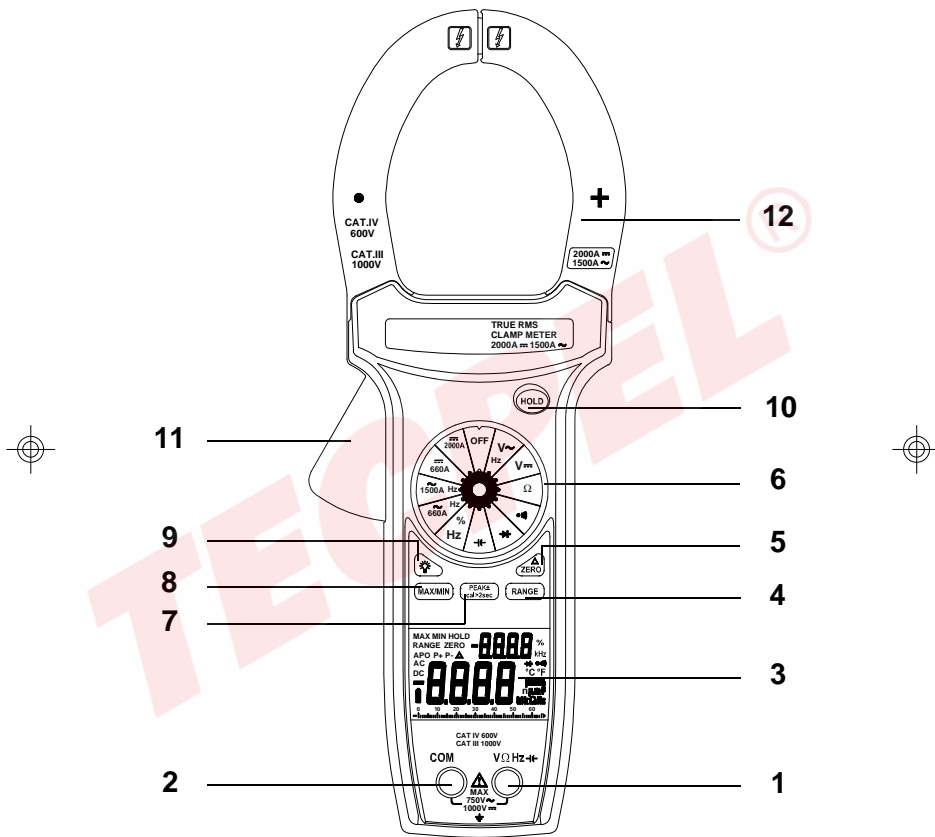



### 1. VWHz% ← →, Voltage, Ohms, Frequency, Duty cycle, Capacitance, Diode Input Terminal

This is the positive input terminal for Voltage, Ohms, Frequency, Duty cycle, Capacitance, Diode measurements. Connection is made to it using the red test lead.

### 2. COM Common Terminal

This is the negative (ground) input terminal for all measurement modes except current. Connection is made to it using the black test lead.

### 3. Display

The display indicates the measured value of a signal, function mode, and annunciator.

### 4. RANGE Button

The meter also has a manual range mode. In manual range, you select and lock the meter in a range. To manually select a range: Press [RANGE] button to hold the selected range. Subsequently pressing the [RANGE] button will select each range in sequence from the lowest to highest range. Hold the button for 2 seconds to return to the Autorange Mode.

### 5. ZERO $\Delta$ Button

On the DC current ranges, the  $\Delta$ /ZERO button works as the zero mode, and on other functions, the  $\Delta$ /ZERO button works as the relative mode. Press REL button again to exit the mode. Press ZERO button for more than 2 seconds to exit.

In the Relative mode, the value shown on the LCD is always the difference between the stored reference value and the present reading. For example, if the reference value is 24.00V and the present reading is 12.50V, the display will indicate -11.50V. If the new reading is the same as the reference value, the display will be zero.

### 6. Function/Range selector rotary switch

This rotary switch selects the function, and selects the desired range.

5





## 7. PEAK ± Button

1. Record the peak+ or peak- value in a measurement. It is usable with AC voltage, AC current measurements. If the pressed time >2 sec, the PEAK function will enter to calibration mode, the LCD will show "CAL" and the internal buffer will remember the internal op off set voltage then back to the measure mode.

2. Response time: more than 1ms. 3. The recorded value of PEAK function will show on the sub-display, and the value being measured will show on the main-display.

## 8. MAX / MIN Button

The "MAX" displays the maximum value of measurements. The "MIN" displays the minimum value of measurements. press MAX/MIN button for more than 2 seconds to exit. The recorded value of MAX/MIN function will show on the sub-display, and the value being measured will show on the main-display.

## 9. Backlight Button

Press the  button to activate the backlight for approximately 60 second.



## 10. HOLD Button

Press [HOLD] button to toggle in and out of the Data Hold mode.

In the data hold mode, the " HOLD" annunciator is displayed and the last reading is held on the display.

Press [HOLD] button again to release the hold and current readings are once again displayed.

## 11. Trigger

Press the lever to open the transformer. When the lever is released, the jaws will close again.

## 12. Transformer jaws

Pick up the AC or DC current flowing through the conductor. The "+" marking on the jaw indicates direction of DC current existing on the conductor being tested which follows forward and vertically with jaws, and reading shown on display is positive.







### 13. Other Functions

#### Auto Power off

1. Auto power off: approx. 30 minutes.
2. After auto power off, press any button to restart the meter, and the reading of measurement will be maintained in the display.

#### Cancellation Of Auto Power Off Feature:

Press and hold the (RANGE) button while rotating function switch from off to any position to turn the meter on. The auto power off feature is disabled.

Note "APO" annunciator is missing from the LCD.

### HOW TO MAKE MEASUREMENTS

Before making any measurements read safety precautions. Always examine the instrument and accessories used with the instrument for damage, contamination (excessive dirt, grease, etc.) and defects. Examine the test leads for cracked or frayed insulation and make sure the lead plugs fit snugly into the instrument terminals. If any abnormal conditions exist, do not attempt to make any measurements.



### VOLTAGE MEASUREMENTS

1. Turn off power to the device under test and discharge all capacitors.
2. Plug the black test lead into the COM input jack on the meter and connect the test lead tip to a grounded point (the reference point for measurement of voltage).
3. Set the Function/Range switch to the "V $\sim$  / V $\equiv$ " position.

#### WARNING

To avoid possible electric shock, instrument damage and / or equipment damage, do not attempt to take any voltage measurements if the voltage is above 1000Vdc / 750Vac. 1000Vdc and 750Vac are the maximum voltages that this instrument is designed to measure.





4. Plug the red test lead into the  $V\Omega$  input jack on the meter and connect the circuit where a voltage measurement is required. Voltage is always measured in parallel across a test point.
5. Turn on power the circuit /device to be measured and make the voltage measurement reduce the range setting if set too high until a satisfactory reading is obtained.
6. After completing the measurement, turn off power to the circuit / device under test , discharge all capacitors and disconnect the meter test leads.

## CURRENT MEASUREMENTS

### WARNING

These Snap-Arounds are designed to take current measurements on circuits with a maximum voltage difference of 1000VAC between any conductor and ground potential. Using the Snap-Around for current measurements on circuits above this voltage may cause electric shock, instrument damage and/or damage to the equipment under test. Before measuring current make certain that the test leads are removed from the instrument.

Do not take current readings on circuits where the maximum current potential is not known . Do not exceed the maximum current that this instrument is designed to measure.

1. Set the Function/Range switch to the  $A^{\sim}$  / $A\sim$  position.
2. Press the trigger to open the transformer jaws and clamp them around a conductor. Jaws should be completely closed before taking a reading.
3. The most accurate reading will be obtained by keeping the conductor across center of the transformer jaws.
4. The reading will be indicated on the display.
5. Reduce the range setting if set too high until a satisfactory best resolution reading is obtained.





## RESISTANCE MEASUREMENTS

1. Set the Function/Range switch to the "Ω" position.
2. Turn off power to the circuit under test. External Voltage across the components causes invalid reading.
3. Connect the red test lead to the "VΩ" jack and the black test lead to the "COM" jack.
4. Connect the test leads to the points of measurements and read the value from the display.

## CONTINUITY MEASUREMENTS

1. Set the Function switch to the "🔊" position.
2. Turn off power to the circuit under test. External Voltage across the components causes invalid reading.
3. Connect the test leads to the two points at which continuity is to be tested. The buzzer will sound if the resistance is less than approximately 30Ω.



## DIODE TESTS

1. Set the Function/Range switch to the "▶" position.
2. Turn off power to the circuit under test. External voltage across the components causes invalid readings.
3. Connect the red test lead to the "VΩ" jack and the black test lead to the "COM" jack.
4. Touch probes to the diode. A forward-voltage drop is about 0.6V (typical for a silicon diode).
5. Reverse probes. If the diode is good, "OL" is displayed. If the diode is shorted, "0.00" or another number is displayed.
6. If the diode is open, "OL" is displayed in both directions.
7. Audible Indication: Less than 0.03V.





## CAPACITANCE MEASUREMENTS

1. Set the Function/Range switch to the "F" position.
2. Connect the red test lead to the "VΩ" jack and the black test lead to the "COM" jack.
3. Touch the probes to the capacitor. Observe polarity when measuring polarized capacitors.
4. Read the capacitance directly from the display.
5. Discharge the capacitor before taking capacitance measurements.
6. The meter has a residual capacitance in the 6.6nF and 660nF ranges, which is a normal status. Before taking measurements, press the Relative D button to zero the residual capacitance.
7. When the capacitor to be tested is connected, if "dIS.C" symbol indicate on LCD, it means there is voltage existing in the tested capacitor and to be discharged before testing.

## FREQUENCY MEASUREMENTS

1. Set the Function/Range switch to the "Hz/%" position.
2. Connect the red test lead to the "VΩ" jack and the black test lead to the "COM" jack.
3. Connect the test leads to the point of measurement and read the frequency from the display.

## %DUTY CYCLE MEASUREMENTS

1. Set the Function/Range switch to the "Hz/%" position.
2. Connect the red test lead to the "VΩ" jack and the black test lead to the "COM" jack.
3. The readings of % DUTY CYCLE measurements will show on the sub-display.





## SPECIFICATIONS

- **Display:** 6600 counts, 66 segments analog bar-graph.
- **Polarity:** Automatic, (-) negative polarity indication.
- **Overrange Indication: (OL) or (-OL) is displayed.**
- **Low Battery Indication:** The "■" is displayed when the battery voltage drops below accurate operating level.
- **Measurement Rate:** 2.8/sec, nominal. 28/sec, Analog bar-graph.
- **Operating Environment:** 0°C to 50°C at < 70% R.H.
- **Storage Environment:** -20°C to 60°C at < 80% R.H.
- **Temperature Coefficient:** 0.1 × (specified accuracy) Per °C. (0°C to 18°C, 28°C or 50°C).
- **Auto Power Off:** 30 minutes after rotary switch or mode changes.
- **Altitude:** 6561.7 Feet (2000m)
- **Power:** Standard 9-volt battery, NEDA 1604, IEC 6F22, JIS 006P.
- **Battery Life:** 75 hours typical with carbon-zinc battery.
- **Jaw Opening Capability:** 57mm conductor, 70 × 18mm bus bar.
- **Size (H × W × D):** 11.1 × 4.3 × 2.1 inches (281 × 108 × 53 mm).
- **Weight:** Approx. 20.1 OZ/570g grams (including battery)

Accuracy is given as  $\pm$ ([% of reading]+[number of least significant digits]) at 18°C to 28°C, with relative humidity up to 70%.





### DC Volts

Range	Resolution	Accuracy	Input Impedance
660mV	0.1mV	$\pm (0.5\% \text{ rdg} + 2\text{d})$	$> 100\text{M}\Omega$
6.6V	1mV	$\pm (0.5\% \text{ rdg} + 2\text{d})$	$10\text{M}\Omega$
66V	10mV	$\pm (0.5\% \text{ rdg} + 2\text{d})$	$9.1\text{M}\Omega$
660V	100mV	$\pm (0.5\% \text{ rdg} + 2\text{d})$	$9.1\text{M}\Omega$
1000V	1V	$\pm (0.5\% \text{ rdg} + 2\text{d})$	$9.1\text{M}\Omega$

Overload protection: 1000V DC or 750V AC rms

### AC Volts (True RMS)

Range	Resolution	Accuracy (50~500Hz)	Input Impedance
660mV	0.1mV	$\pm (1.5\% \text{ rdg} + 8\text{d})$ 50~100Hz	$> 100\text{M}\Omega$
6.6V	1mV	$\pm (1.5\% \text{ rdg} + 8\text{d})$ 50~500Hz	$10\text{M}\Omega$
66V	10mV	$\pm (1.5\% \text{ rdg} + 8\text{d})$ 50~500Hz	$9.1\text{M}\Omega$
660V	100mV	$\pm (1.5\% \text{ rdg} + 8\text{d})$ 50~500Hz	$9.1\text{M}\Omega$
750V	1V	$\pm (1.5\% \text{ rdg} + 8\text{d})$ 50~500Hz	$9.1\text{M}\Omega$

Crest Factor:  $\leq 3$

Peak Hold:  $\pm(3.0\% \text{ rdg} + 200 \text{ dgts})$  on 66V to 750V ranges

AC coupled true rms specified from 5% to 100% of range

FREQUENCY Ranges: 50Hz ~ 1kHz.

Accuracy:  $\pm(0.1\% \text{ rdg} + 5 \text{ dgts})$

Minimum Input voltage Range:  $>500\text{dgts}$ .

The readings of frequency measurements will show on the sub-display.

Overload protection: 1000V DC or 750V AC rms





### AC current (True RMS)

Range	Resolution	Accuracy (50 ~ 400Hz)
660A	0.1A	0~660A±(2.0% rdg+10d)50~60Hz 0~660A±(3.0% rdg+10d)61~400Hz
1500A	1A	660~1000A±(2.5% rdg+10d)50~60Hz 660~1000A±(3.5% rdg+10d)61~400Hz 1000~1500A±(5.0% rdg+10d)50~400Hz

Crest Factor:  $\leq 3$

Peak Hold:  $\pm(3.0\% \text{ rdg} + 200 \text{ dgts})$

AC coupled true rms specified from 5% to 100% of range

FREQUENCY Ranges: 50Hz ~ 1kHz.

Accuracy:  $\pm(0.1\% \text{ rdg} + 5 \text{ dgts})$

Minimum Input current Range:  $>500\text{dgts}$ .

The readings of frequency measurements will show on the sub-display.

Overload protection: 1500A AC.



### DC current

Range	Resolution	Accuracy
660A	0.1A	0~660A±(2.0% rdg+5d)
2000A	1A	660~1000A±(3.0% rdg+5d) 1000~2000A±(5.0% rdg+5d)

Overload protection: 2000A DC for 60 seconds maximum.





### Resistance

Range	Resolution	Accuracy	Open Circuit Volts
660Ω	0.1Ω	± (1.0% rdg + 5d)	-3.5V dc
6.6kΩ	1Ω	± (1.0% rdg + 5d)	-1.1V dc
66kΩ	10Ω	± (1.0% rdg + 5d)	-1.1V dc
660kΩ	100Ω	± (1.0% rdg + 5d)	-1.1V dc
6.6MΩ	1kΩ	± (2.0% rdg + 5d)	-1.1V dc
66MΩ	10kΩ	± (3.5% rdg + 5d)	-1.1V dc

Overload protection: 600V DC or AC rms

### Continuity Test

Range	Audible Threshold	Response Time	Open Circuit Volts
660Ω	Less than 30Ω	Approx. 100ms	-3.5V dc

Overload protection: 600V DC or AC rms



### Diode Test

Range	Resolution	Accuracy	Test Current	Open Circuit Volts
2V	1mV	±(1.5% rdg +5d)	0.8mA	3.2V dc typical

Audible indication: Less than 0.03V

Overload protection: 600V DC or AC rms



### Capacitance

Range	Resolution	Accuracy
6.6 nF	1PF	±(3.0% rdg + 30d)
66 nF	10PF	±(3.0% rdg + 10d)
660 nF	100PF	±(3.0% rdg + 30d)
6.6 μF	1nF	±(3.0% rdg + 10d)
66 μF	10nF	±(3.0% rdg + 10d)
660 μF	100nF	±(3.0% rdg + 10d)
6.6mF	1uF	±(5.0% rdg + 10d)

Overload Protection: 600V DC or AC rms







### %Duty Cycle

Range	Resolution	Pulse Width	Accuracy ( 5V logic)
5% to 95%	0.1%	>10us	$\pm(2.0\% \text{ rdg}+10d)$

Frequency range: 5% to 95% ( 40Hz to 20kHz )

The readings of % DUTY CYCLE measurements will show on the sub-display.

Overload protection: 600V DC or AC rms

### Frequency

Range	Resolution	Accuracy	Trigger Level
66Hz	0.01Hz	$\pm(0.1\% \text{ rdg}+5d)$	>3.5V
660Hz	0.1Hz	$\pm(0.1\% \text{ rdg}+5d)$	>3.5V
6.6KHz	1Hz	$\pm(0.1\% \text{ rdg}+5d)$	>3.5V
66KHz	10Hz	$\pm(0.1\% \text{ rdg}+5d)$	>3.5V
660KHz	100Hz	$\pm(0.1\% \text{ rdg}+5d)$	>3.5V
1MHz	1KHz	$\pm(0.1\% \text{ rdg}+5d)$	>3.5V

Minimum Input Range: > 10Hz

Minimum pluse width: > 1us

Duty cycle limits: > 30% and < 70%

Overload protection: 600VDC or AC rms





## MAINTENANCE

Maintenance consists of periodic cleaning and battery replacement. The exterior of the instrument can be cleaned with a dry clean cloth to remove any oil, grease or grime. Never use liquid solvents or detergents. Repairs or servicing not covered in this manual should only be performed by qualified personnel.

## REPLACING THE BATTERY

### WARNING

TO AVOID ELECTRICAL SHOCK, DISCONNECT THE TEST LEADS AND ANY INPUT SIGNALS BEFORE REPLACING THE BATTERY. REPLACE ONLY WITH SAME TYPE OF BATTERY.



This meter is powered by a NEDA type 1604 or equivalent 9-volt battery. When the meter displays the "  " the battery must be replaced to maintain proper operation. Use the following procedure to replacing the battery:



1. Disconnect test leads from any live source, turn the rotary switch to OFF, and remove the test leads from the input terminals.
2. The battery cover is secured to the bottom case by a screw. Using a Phillips-head screwdriver, remove the screw from the battery cover and remove the battery cover.
3. Remove battery and replace with a new equivalent 9-volt battery.
4. Replace the battery cover and reinstall the screw.





TECPEL®



7000-1878A(2608C)

