

# TECPEL<sup>®</sup> DTM-322

## HUMIDITY TEMPERATURE METER

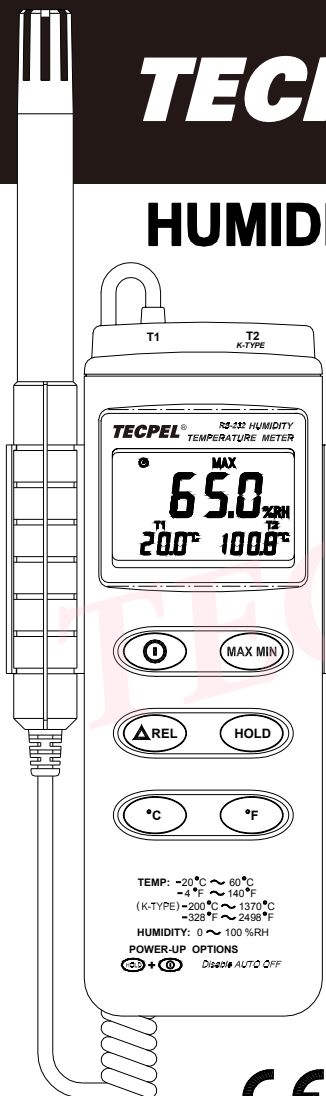

TEMP: -20°C ~ 60°C  
-4°F ~ 140°F  
(K-TYPE) -200°C ~ 1370°C  
-328°F ~ 2498°F  
HUMIDITY: 0 ~ 100%RH  
POWER-UP OPTIONS  
Ⓢ + ⓐ Disable AUTO OFF



Instruction Manual

*Instruction Manual*

---

# **HUMIDITY TEMPERATURE METER**

**CE**

**TECPEL**

# CONTENTS

---

<i>TITLE</i>	<i>PAGE</i>
I. Safety Information.....	1
II. Introduction.....	1
III. Specifications.....	1
IV. Symbol Definition and Button Location.....	2
V. Operation Instructions.....	3
<b>4.1 Power-Up</b> .....	3
<b>4.2 Humidity and Temperature Measurement</b> .....	3
<b>4.3 Connection the Thermocouples ( T2 channel )</b> .....	3
<b>4.4 Selecting the Temperature Scale</b> .....	3
<b>4.5 Data-Hold Operation</b> .....	3
<b>4.6 MAX/MIN Operation</b> .....	4
<b>4.7 Relative Operation</b> .....	4
<b>4.8 Auto Power Off</b> .....	4
<b>4.9 Low Battery Condition</b> .....	4
<b>4.10 Digital Output</b> .....	4
VI. Calibration Procedure.....	5

### I. Safety Information

Read the following safety information carefully before attempting to operate or service the meter. Use the meter only as specified in this manual; otherwise, the protection provided by the meter may be impaired.

#### Environment conditions

- Altitude up to 2000 meters
- Relatively humidity 90% max.
- Operation Ambient 0 ~ 50°C

#### Maintenance & Clearing

- Repairs or servicing not covered in this manual should only be performed by qualified personnel.
- Periodically wipe the case with a dry cloth. Do not use abrasives or solvents on this instrument.

#### Safety symbols



Comply with EMC



Read safety Information first.

### II. Introduction:

This instrument is a digital Humidity / Temperature meter for use a polymer capacitive and semiconductor sensor and K type thermocouple. This operations manual contains general product information and specification.

### III. Specifications:

**Numerical Display :** 4 digital Liquid Crystal Display.

**Measurement Range :** Humidity: 0%~100%RH

Temperature: T1: -20°C~+60°C , -4°F~+140°F

T2: -200°C~+1370°C , -328°F~+2498°F

**Resolution :** Humidity: 0.1%RH

Temperature: T1: 0.1°C , 0.1°F

T2: -200°C~200°C 0.1°C ; 200°C~1370°C 1°C

-200°F~200°F 0.1°F ; else 1°F

**Accuracy :** Humidity:±2.5%RH at 25°C

Temperature: T1: ±0.7°C, ±1.4°F

T2: Please check the following table.

at (23+5°C)

Range	Accuracy
-200°C ~ 200°C	±(0.3% reading + 1°C)
200°C ~ 400°C	±(0.5% reading + 1°C)
400°C~1370°C	±(0.3% reading + 1°C)
-328°F ~ -200°F	±(0.5% reading + 2°F)
-200°F ~ 2498°F	±(0.3% reading + 2°F)

#### Temperature Coefficient:

For ambient temperatures from 0°C ~ 18°C and 28°C ~ 50°C, for each °C ambient below 18°C or above 28°C add the following tolerance into the accuracy spec.

0.01% of reading + 0.03°C

0.01% of reading + 0.06°F



#### Note:

The basic accuracy Specification does not include the error of the probe. Please refer to the probe accuracy specification for additional details.

**Response Time :** Humidity: 75 sec. In slowly moving air  
 Temperature: 40 sec. in slowly moving air (T1)

**Signal Output :** RS-232 Data Output

**Operating Environment :** 0°C~50°C, 32°F~122°F 0 to 90%RH non-condensing

**Storage Environment :** -10°C~60°C, 14°F~140°F 0 to 80%RH non-condensing

**Power Requirements :** Battery: One 9V battery 006p or IEC 6F22 or NEDA1604  
 AC adapter: 9Vdc / 10mA minimum

**Plug Diameter:** 3.5 mm×1.35mm

**Battery Life :** Approx. 100hrs with alkaline battery

**Weight :** Approx.320g

**Dimension :** Meter = 186(L)×64(W)×30(H)mm ; 10.8(L)×2.5(W)×1.2(H)inch  
 Probe = 190(L)×15(D)mm ; 7.5(L)×0.6(D)inch

**Accessories :** Instruction Manual, 9V Battery, Carrying Case, Probe Holder, K type bead thermocouple probe.

#### IV. Symbol Definition and Button Location:

°C°F : Centigrade and Fahrenheit indication.

%RH : Relative Humidity indication.

MAX : The Maximum value is now being displayed

MIN : The Minimum value is now being displayed

 : This indicates auto power off is enabled.

 : This indicates that the display data is being held.

m-d : month and day

h:m : hour and minute

m:s : minute and second

Y : year

 : The Battery is not sufficient for proper operation.

K : Thermocouple type indication.

ΔREL : The reading is now under relative mode.



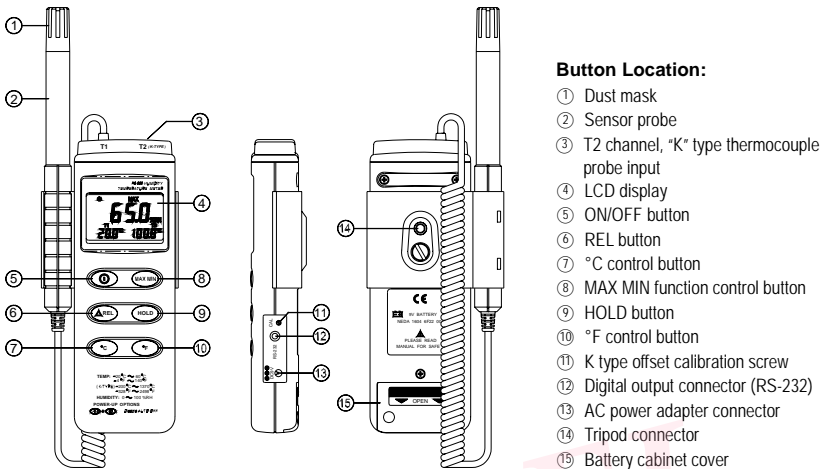

**Button Location:**

- ① Dust mask
- ② Sensor probe
- ③ T2 channel, "K" type thermocouple probe input
- ④ LCD display
- ⑤ ON/OFF button
- ⑥ REL button
- ⑦ °C control button
- ⑧ MAX MIN function control button
- ⑨ HOLD button
- ⑩ °F control button
- ⑪ K type offset calibration screw
- ⑫ Digital output connector (RS-232)
- ⑬ AC power adapter connector
- ⑭ Tripod connector
- ⑮ Battery cabinet cover

*V. Operation Instructions:*

**4.1 Power-Up**

Press the power button to turn the Humidity Temperature Meter ON or OFF.

**4.2 Humidity and Temperature Measurement**

For measurement, place the sensor probe in the tested environment.

**4.3 Connection the Thermocouples ( T2 channel )**

For measurement, plug the thermocouple probe into the input connector.

**4.4 Selecting the Temperature Scale**

When the meter was first power on, the default scale setting is set at Celsius (°C) scale. The user may change it to Fahrenheit (°F) by pressing " °F " button and vice versa to Celsius by pressing " °C " button.

**4.5 Data-Hold Operation**

The user may hold the present reading and keep it on the display by pressing the "HOLD" button. When the held data is no longer needed, one may release the data-hold operation by pressing "HOLD" button again.

When the meter is under Data Hold operation, the "MAX MIN" and " °C " " °F " " ΔREL " button are disabled. (when you press " °C " " °F " " ΔREL " and "MAX MIN" button in HOLD mode, there will be two continuous beeps)

**4.6 MAX/MIN Operation:**

When one press the "MAX MIN" button the meter will enter the MAX/MIN mode. Under this mode the maximum value, minimum value is kept in the memory simultaneously and updated with every new data.

When the MAX symbol is display, the Maximum is shown on the display.

Press "MAX MIN" again, then the MIN symbol is on the display and also the minimum reading.

Press "MAX MIN" again, MAX, and MIN will blink together. This means that all these data is updated in the memory and the reading is the present temperature.

One may press "MAX MIN" to circulate the display mode among these options.

When the meter is under "MAX MIN" operation, " °C " " °F " " ΔREL " button are disabled.(when you press " °C " " °F " " ΔREL " button in "MAX MIN" mode, there will be two continuous beep)

To exit the MAX/MIN mode, one may press and hold "MAX MIN" for two seconds.

#### 4.7 Relative Operation:

When one press the " ΔREL " button, the meter will memorize the present reading and the difference between the new reading and the memorized data will be shown on the display, Press the " ΔREL " button again to exit the Relative operation. When the meter is under relative operation, " °C/°F " button is disabled. ( when you press " °C " " °F " button in relative mode , there will be two continuous beep )

#### 4.8 Auto Power Off:

By default, when the meter is powered on, it is under auto power off mode. The meter will power itself off after 30 minutes if no key operation and no RS232 communication.

Combination at power on can disable auto power off.

One may press and hold "HOLD" button and then power on the meter and there will be two successive beeps to indicate that auto power off is disabled and the  will not show up.

#### 4.9 Low Battery Condition

When the battery voltage is under proper operation requirement, the  symbol will show on the LCD and the battery need to be replaced with new one.

#### 4.10 Digital Output:

The Digital Output is a 9600bps N 81 serial interface.

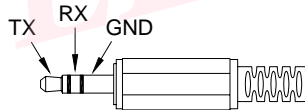

### WARNING!

1. Don't touch or manipulate the sensor.
2. Don't expose the sensor to direct light , this causes a false reading.
3. Don't expose the sensor to static electricity.

#### Appendix: Thermo couple probe specification

Model	Range	Tolerances	Description
TP-K01	-50°C to 200°C	±2.2°C or ±0.75%	with Teflon tape insulation Maximum insulating temperature : 260°C
Bead probe	-58°F to 392°F	(±3.6°F or ±0.75%)	

#### TP-K01:

probe for general condition measurements, especially for complex and hard to reach places.



## VI .Calibration Procedure

### Humidity Calibration:

1. Turn the unit off. Press and hold **MAX/MIN**, **HOLD** and **°C** keys. While these three keys are pressed, turn the power on. Release these keys and all the segments on the LCD will blink.
2. After step one, within 3 seconds, the user have to press **°F** and **REL** key at the same time to enter the calibration mode or the tester will go back to normal operation mode.
3. When the tester get into calibration mode, the humidity reading will blink and "CAL1" will appear on the second display.
4. Insert the humidity probe into the standard humidity cavity of 32.8%RH@25°C. Wait until the system to stabilize for 20 minutes then press **MAX/MIN** button to create the calibration data. If the unit recognizes the value is out of tolerance, the unit will sound 2 beeps and still remain at "CAL1"mode. If the tester recognizes the value is within tolerance, new calibration data is created and the tester will go into "CAL2" mode, which will be indicated by "CAL2" at 2<sup>nd</sup> display.
5. Insert the humidity probe into the standard humidity cavity of 75.3%RH@25°C. Wait until the system to stabilize for 20 minutes then press **MAX/MIN** button to create the calibration data. If the unit recognizes the value is out of tolerance, the unit will sound 2 beeps and still remain at "CAL2"mode. If the tester recognizes the value is within tolerance, new calibration data will be written into the memory and the calibration is done.

### Remark:

1. When the user perform the humidity calibration, the environment should be kept at the stable condition (i.e. Constant temperature and constant humidity in the lab.) to increase the accuracy.
2. After the probe insert into the standard humidity cavity, the operator should wait at least 20 minutes to let the condition in the cavity to stabilize.
3. During the calibration, if the user press **POWER** button at any time, the tester will go back to normal operation mode and no calibration data will be changed.
4. During the calibration mode, the user can restore the factory default value by press the **HOLD** and **°C** buttons at the same time.
5. Because it takes some time to stabilize the system, we recommend the operator first insert the probe into the 32.8%RH@25°C standard cavity and wait for at least 20 minutes, then power the unit on and start the calibration process.
6. During the calibration, all the displayed reading is calibrated with the old calibration data and the auto power function is disabled. Until the calibration process is done, the tester will enable auto power function again.
7. During the calibration, the temperature is fixed at °F scale and it is not selectable.

### T1 Temperature Calibration:

1. Turn the unit off. Press and hold **MAX/MIN**, **HOLD** and **°C** keys. While these three keys are pressed, turn the power on. Release these keys and all the segments on the LCD will blink.
2. After step one, within 3 seconds, the user have to press **°F** and **HOLD** key at the same time to enter the calibration mode or the tester will go back to normal operation mode.
3. When the tester get into calibration mode, the temperature reading will blink and "CAL1" will appear on the second display.



4. Insert the probe into standard chamber of 0°C(32°F) and wait the system to stabilize for 20 minutes. Press **MAX/MIN** button to create the calibration data. If the tester recognizes the data is within the tolerance, it will go to "CAL2" mode or it will sound 2 beeps and remain at "CAL1" mode.
5. Insert the probe into standard chamber of 40°C(104°F) and wait the system to stabilize for 20 minutes. Press **MAX/MIN** button to create the calibration data. If the tester recognizes the data is within the tolerance, it will write the calibration data into the memory and leave the calibration mode. If the tester recognizes the calibration data is out of tolerance it will beep 2 times and remain at "CAL2" mode.

**Remarks:**

1. After the probe is in the calibration cavity, wait at least 20 minutes to stabilize the system.
2. During the calibration, the user can leave the process by pressing the **POWER** button at any time and the calibration data will be kept unchanged.
3. During the calibration mode, the user can restore the factory default value by press the **HOLD** and **°C** buttons at the same time.
4. Because it take some time to stabilize the system, we recommend the operator first insert the probe into the 0°C standard cavity and wait for at least 20 minutes, then power the unit on and start the calibration process.
5. During the calibration, all the displayed reading is calibrated with the old calibration data and the auto power function is disabled. Until the calibration process is done, the tester will enable auto power function again.
6. During the calibration, the temperature scale is fixed at °F and it is not selectable.

TECPEL



[www.tecpel.com.tw](http://www.tecpel.com.tw); [www.tecpel.com](http://www.tecpel.com)

TEL: 886-2-2218-3111 FAX: 886-2-2218-3222

Email: [sales@tecpel.com](mailto:sales@tecpel.com) , [tecpelco@gmail.com](mailto:tecpelco@gmail.com)